



Vilan[®]



KIM JESTEŚMY / ABOUT US

Vilan Spółka z ograniczoną odpowiedzialnością jest podmiotem działającym od niedawna, jednak nasze doświadczenie i osób współpracujących z nami w branży ceramicznej jest ponad 20-letnie.

Naszym atutem jest to że w oparciu o nasze doświadczenie i wiedzę potrafimy bardzo szybko:

- ★ zaprojektować,
- ★ skonstruować,
- ★ wyfrezować u siebie na maszynie CNC formę testową,
- ★ odlać i wypalić próbną sztukę,
- ★ ocenić, zbadać i sprawdzić funkcjonalność egzemplarza,
- ★ przeanalizować i wyciągnąć wnioski,
- ★ zbudować matrycę, odpowiednią dla prawie każdej fabryki ceramicznej na świecie.

Śledząc nowe trendy i zapotrzebowania w ceramice łazienkowej opracowaliśmy nowe, własne surowce i rozwiązania. W naszej pracy korzystamy z najnowocześniejszych technologii w projektowaniu, konstruowaniu i budowie form.

Naszymi klientami są fabryki ceramiczne i mebli łazienkowych w Polsce, Unii Europejskiej i również poza nią.

Mając własną pracownię konstrukcyjno-modelarską, zaczynamy szybko powiększać swoją gamę modeli umywalk ceramicznych które oferujemy różnego rodzaju klientom.

Zapraszamy do współpracy ludzi z pasją i wiarą!!! Ludzi, którzy reprezentują producentów mebli łazienkowych, hurtownie i salony łazienkowe oraz hotele.

Tylko tak można stworzyć rzeczy niesamowite, zaskakujące i niepowtarzalne takie, jak nasza nowoczesna i funkcjonalna, ceramika!!!

Vilan Sp. z o. o. is a recently established company, yet our and our copartners experience in the ceramic industry exceeds 20 years.

Our strong point is that on the basis of our experience and knowledge we are able to quickly:

- ★ design,
- ★ construct,
- ★ prepare the test form on a CNC milling machine
- ★ cast and calcinate a sample unit
- ★ assess, examine and check functionality of a unit
- ★ analyse and draw conclusions
- ★ build a matrix suitable for almost every ceramics factory in the world

Following new trend and demands in bathroom ceramics, we have developed our own, new raw materials and solutions. In our work we use the latest technologies in design, creating and building casts. Our customers constitute ceramics and bathroom furniture manufacturers in Poland, the European Union and beyond.

Having our own construction and model workshop, we are swiftly enlarging our selection of ceramic washbasins models, which we offer to miscellaneous customers.

We invite people with passion and faith to cooperate. People, who represent bathroom furniture manufacturers, wholesalers, bathroom showrooms and hotels.

Only in this way it is possible to create incredible, surprising and unique things, like our modern and functional ceramics.



Vilan®

Umywalka/Washbasin
KLEO OVAL

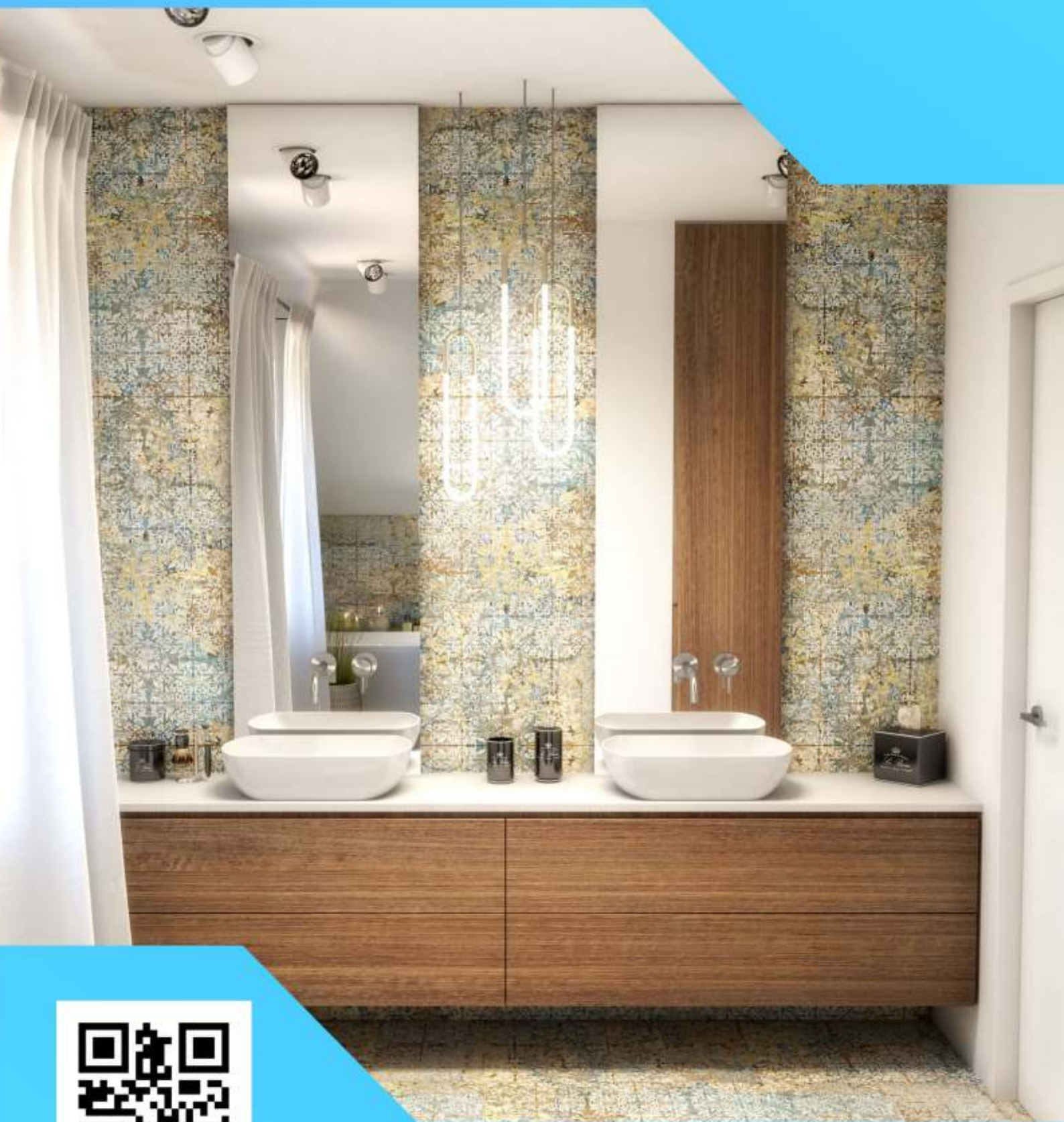

www.vilan.pl

biuro@vilan.pl



KLEO OVAL

Umywalka/Washbasin 50

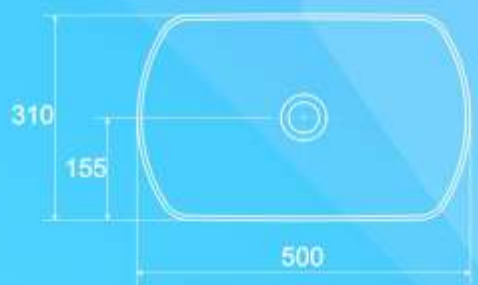

waga / weight: 6.9 kg



Vilan®

Umywalka/Washbasin
KLEO QUADRO



www.vilan.pl

biuro@vilan.pl



KLEO QUADRO

Umywalka/Washbasin 38

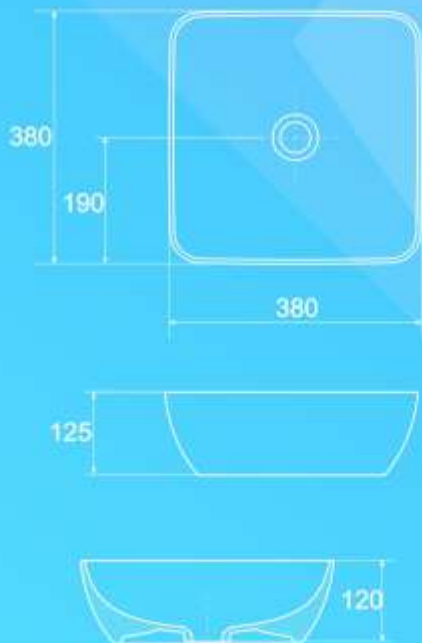

waga / weight: 5.9 kg



Vilan[®]

Umywalka/Washbasin
KLEO SQUARE



www.vilan.pl

biuro@vilan.pl



KLEO SQUARE

Umywalka/Washbasin 50



waga / weight: 6,9 kg



Vilan[®]

Umywalka/Washbasin
KLEO RING



www.vilan.pl

biuro@vilan.pl



KLEO RING

Umywalka/Washbasin 40

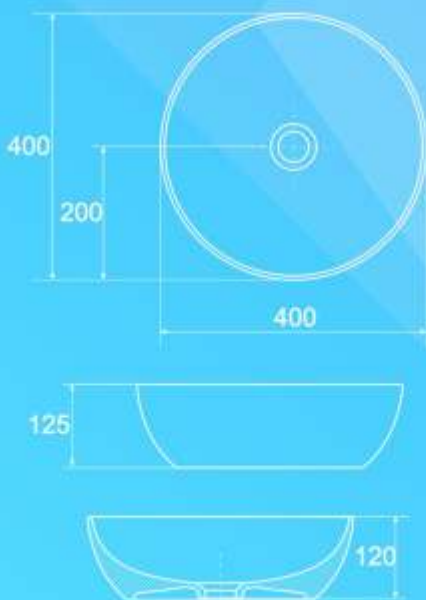

waga / weight: 5,9 kg



Vilan®

Umywalka/Washbasin
SUNDAY SQUARE

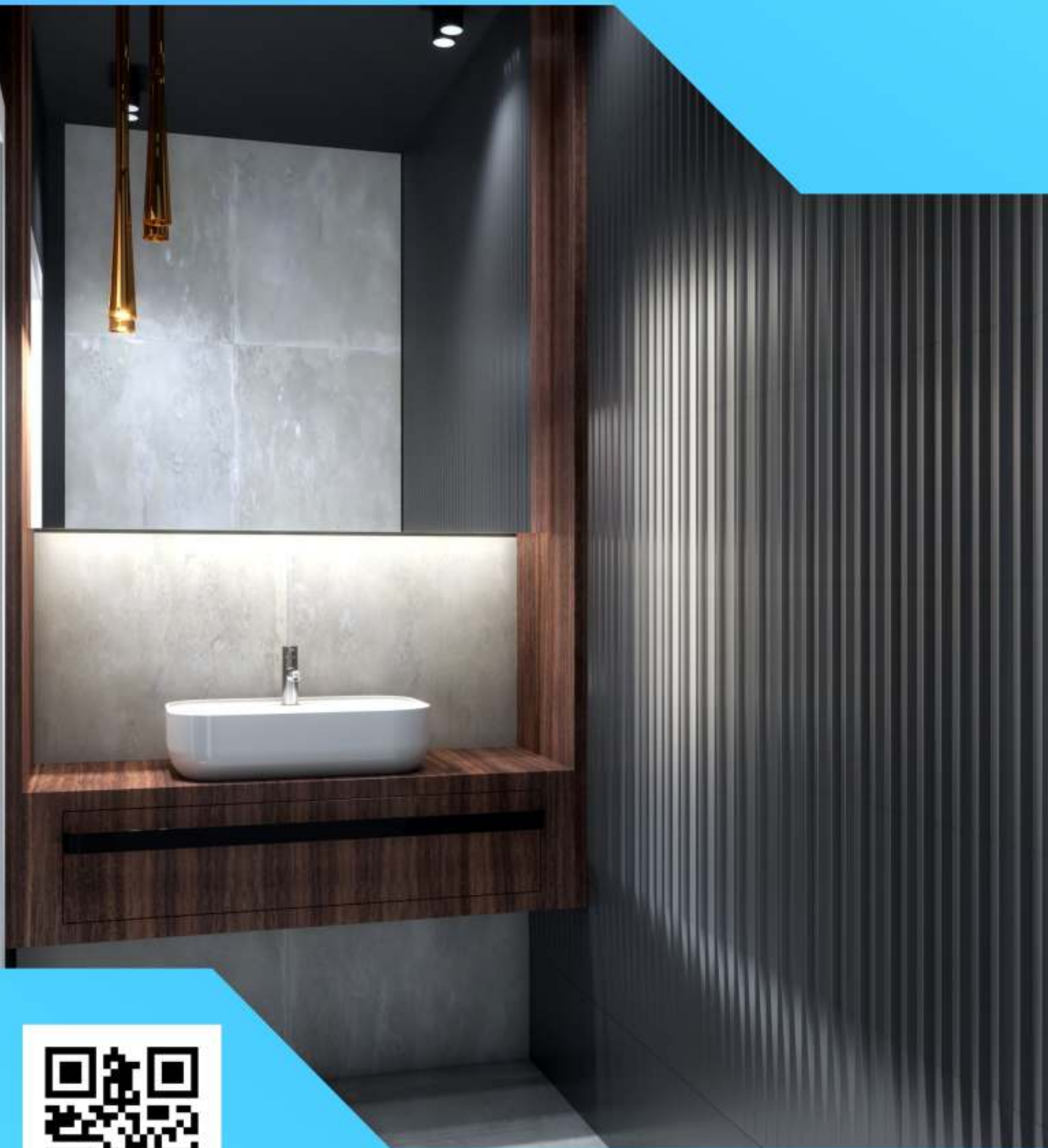

www.vilan.pl

biuro@vilan.pl



SUNDAY SQUARE

Umywalka/Washbasin 57

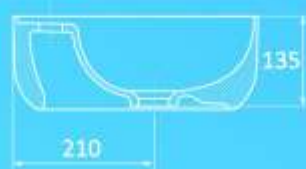

waga / weight: 9 kg



Vilan®

Umywalka/Washbasin
SUNDAY QUADRO



www.vilan.pl

biuro@vilan.pl



Vilan®



SUNDAY QUADRO

Umywalka/Washbasin 37



waga / weight: 7 kg



Vilan®

Umywalka/Washbasin
VERTI QUADRO



www.vilan.pl

biuro@vilan.pl



VERTI QUADRO

Umywarka/Washbasin 38

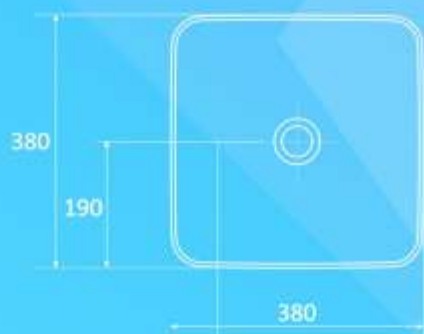

waga / weight: 5.9 kg



Vilan®

Umywalka/Washbasin
VERTI RING



www.vilan.pl

biuro@vilan.pl



VERTI RING

Umywalka/Washbasin 40

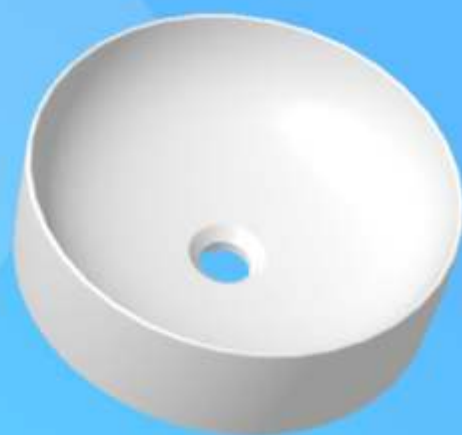
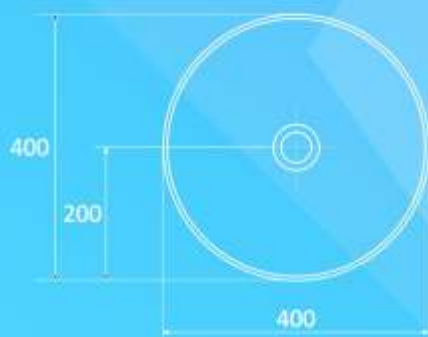

waga / weight: 5.9 kg



Vilan®

Umywalka/Washbasin
VEA 64



www.vilan.pl

biuro@vilan.pl



vilan®



VEA 64

Umywalka/Washbasin 64

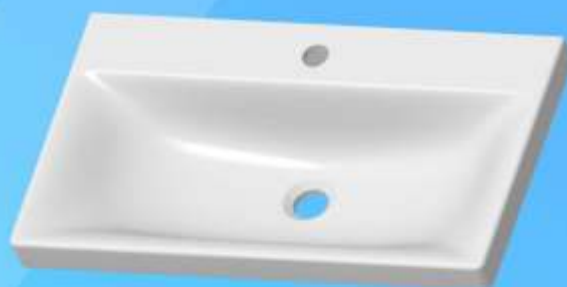

waga / weight: 9,7 kg



Vilan®

Umywalka/Washbasin
VEA 49



www.vilan.pl

biuro@vilan.pl



Vilan



VEA 49

Umywalka/Washbasin 49

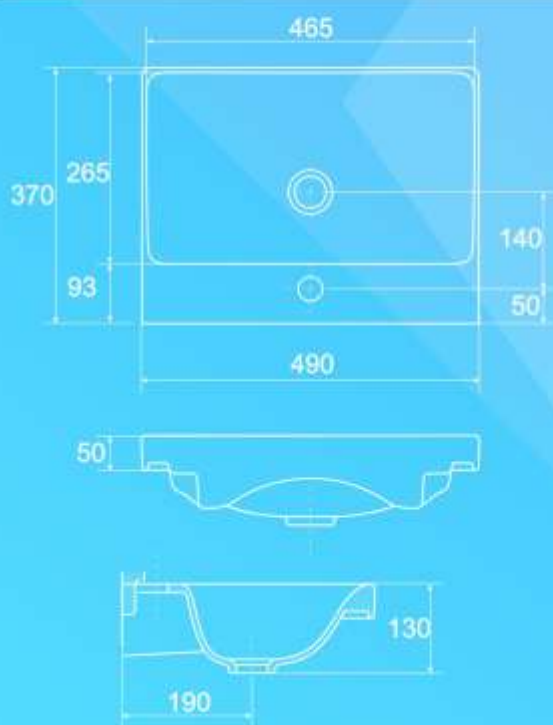

waga / weight: 7,7 kg



Vilan®

Umywalka/Washbasin
VEO 49



www.vilan.pl

biuro@vilan.pl



Vilan®



VEO 49

Umywalka/Washbasin 49

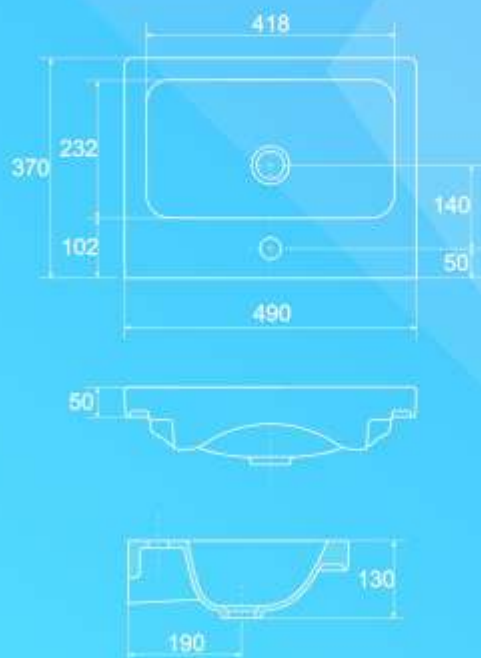

waga / weight: 7,7 kg



Vilan®

Umywalka/Washbasin
VEO 64

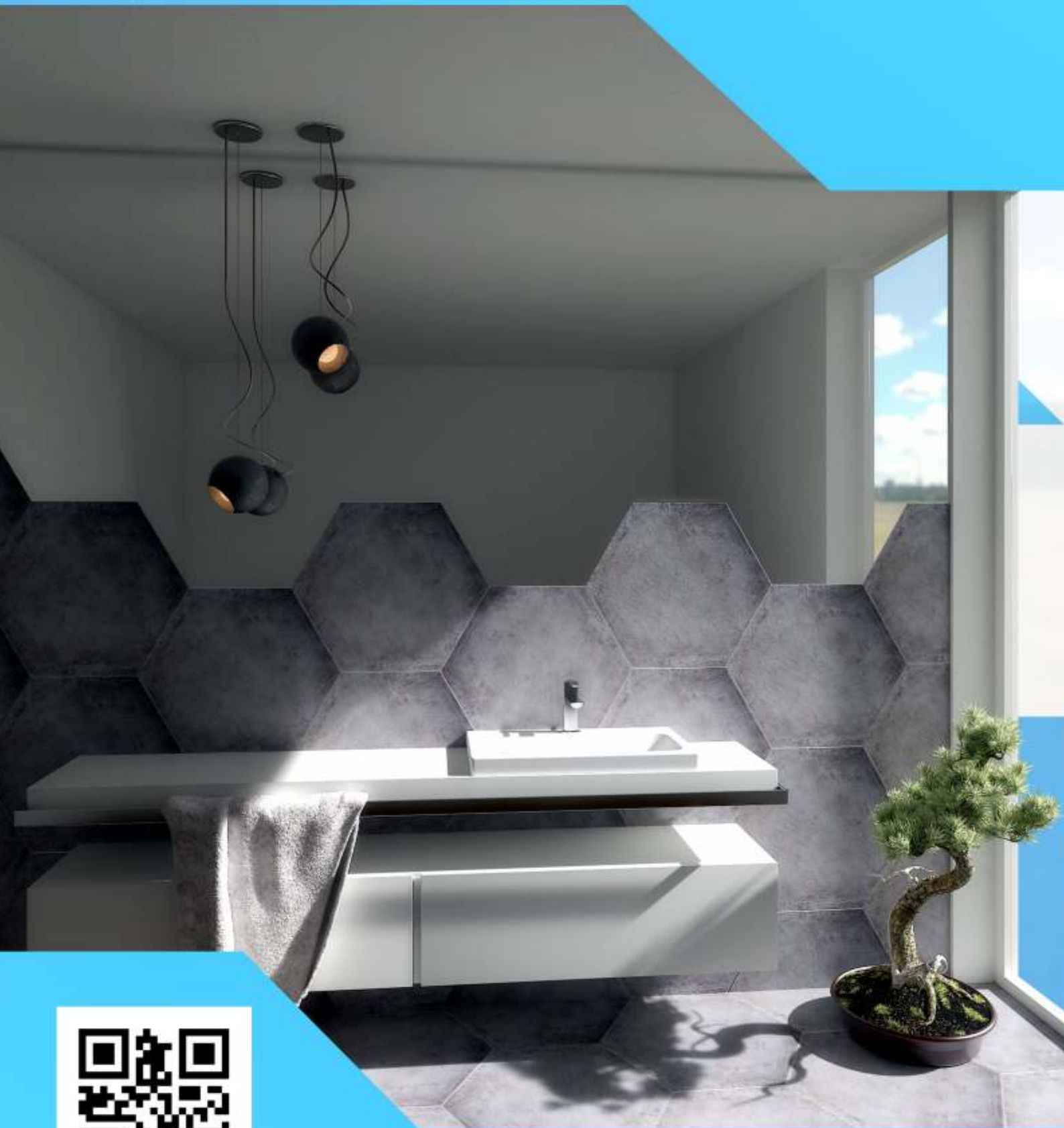

www.vilan.pl

biuro@vilan.pl



VEO 64

Umywalka/Washbasin 64

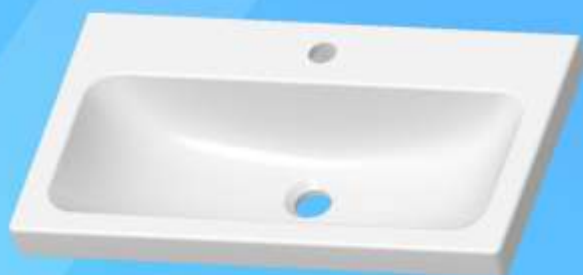
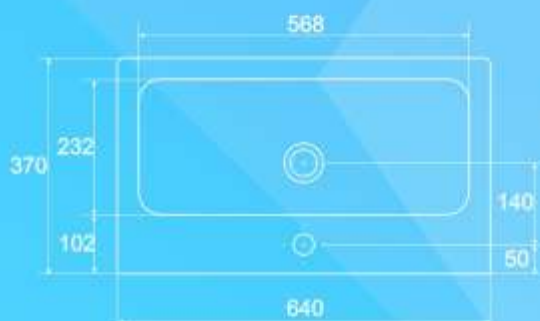

waga / weight: 9,7 kg



Miska wisząca/
Wall hung bowl
OPTIMA



www.vilan.pl

biuro@vilan.pl



Vilan®



OPTIMA

Miska wisząca/
Wall hung bowl



waga / weight: 13,7 kg



Vilan®

Miska wisząca/
Wall hung bowl
OPTIMA II



www.vilan.pl

biuro@vilan.pl



OPTIMA II

Miska wisząca/
Wall hung bowl

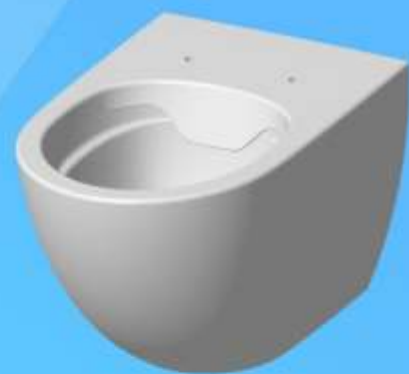

waga / weight: 13,7 kg



RIVA 63

SZAFKA / CABINET 63

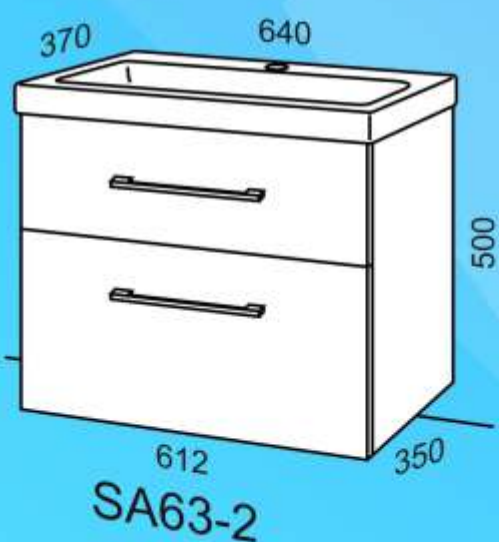

waga / weight: 6 kg

W przygotowaniu / In preparation



ASPEN 40



ASPEN 60



VEA 90



ZANTE 40

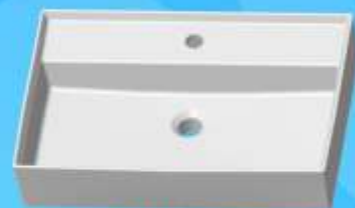

ZANTE 60



VEO 70



VIO 49



VIO 64



Z 80



Miska zawieszana
OPYIMA LITE



Miska zawieszana
ZANTE

...a może zrealizujemy Twój pomysł?

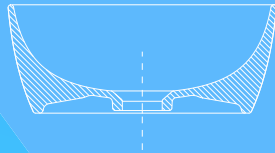
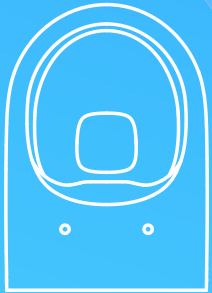
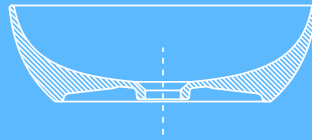
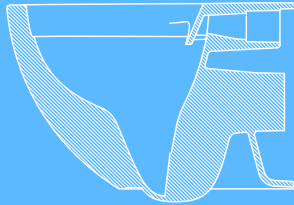
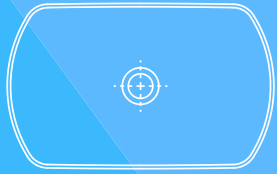

Vilan Sp. z o.o.

Kacice 39, 32-090 Słomniki

NIP: 676-24-86-820

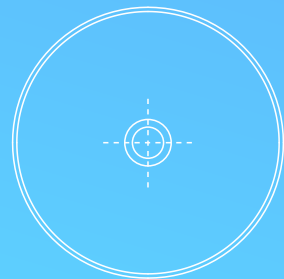

www.vilan.pl

 biuro@vilan.pl



+48 501 33 44 44



+48 790 791 699



+48 601 920 092



+48 601 920 092

